

SETON Safety Sign Alerter

USER GUIDE



PATENT PENDING



What is included

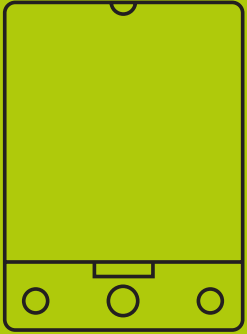

1 x Seton Safety Sign Alerter



4 x D-Cell Batteries

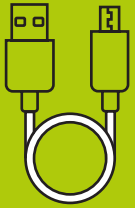

1 x USB Lead

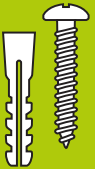

1 x Wall Mounting Hardware



1 x Mounting Template & Downloadable PDF Quick Start Guide

What you will need

Computer with USB port which allows access to external drives

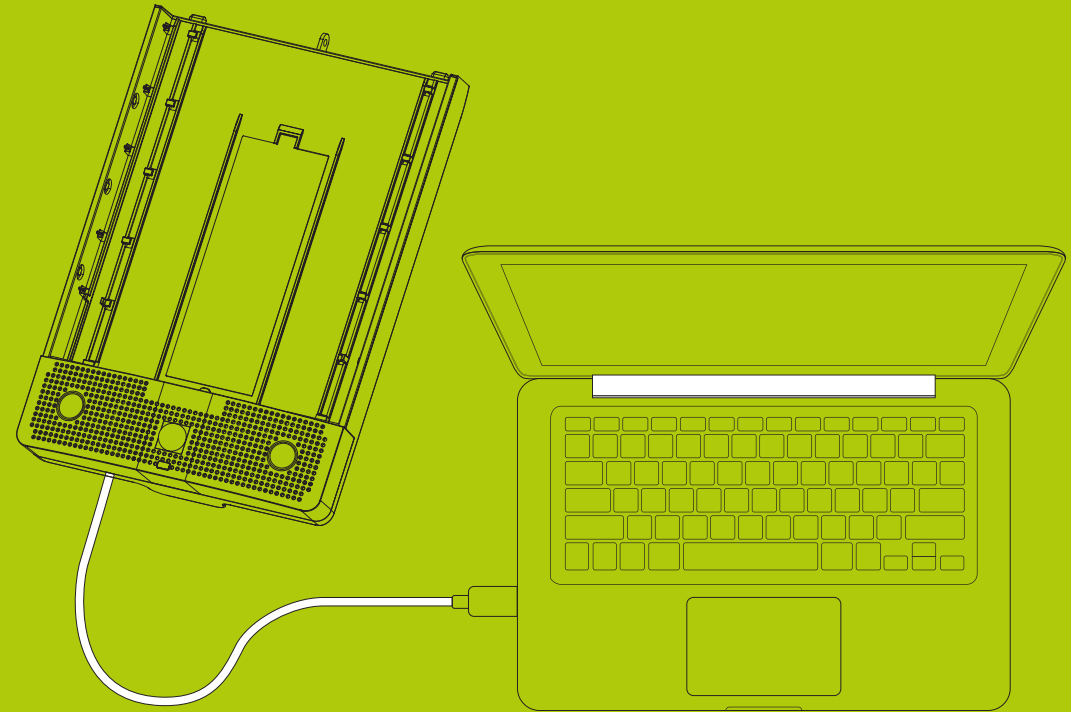

USB Drive (D:)

Operational Setup

1. Remove contents from box

If you are missing anything please contact us 800-263-1623

2. Remove clear front cover

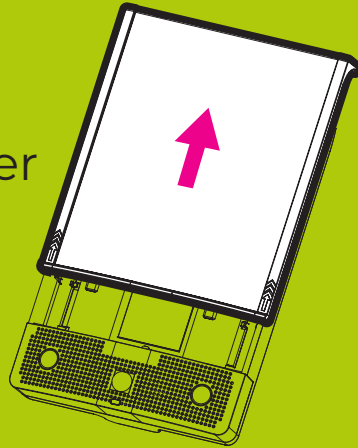

3. Remove battery cover

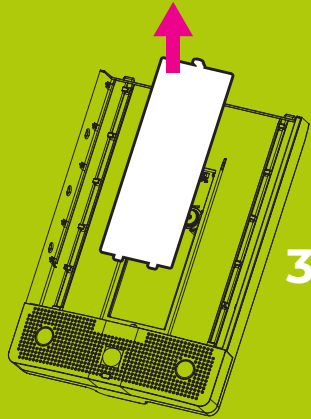

4. Insert batteries

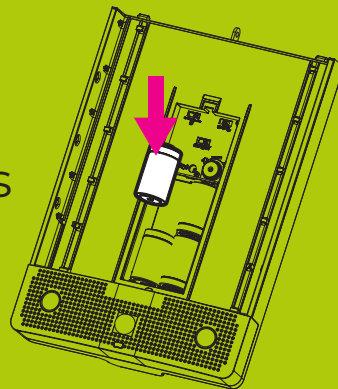

5. Set switches to desired modes



On / Off & Volume

Anti-clockwise and click = OFF
Anti-clockwise = Volume lower
Clockwise = Volume higher

0s · 10s · 30s · 60s



Delay between activations

Delay between activations in seconds



Audio only



Light only



Light and Audio

Direction of Activation



Walking towards



Walking away



Walking away
and towards
different messages



Walking away
and towards
same message



Test Facility

Press (using a pen) to check your volume level

Operational Setup

6. Connect the device to the computer using the supplied USB lead. Plug the larger USB connector end to the computer and the smaller connector end to the device

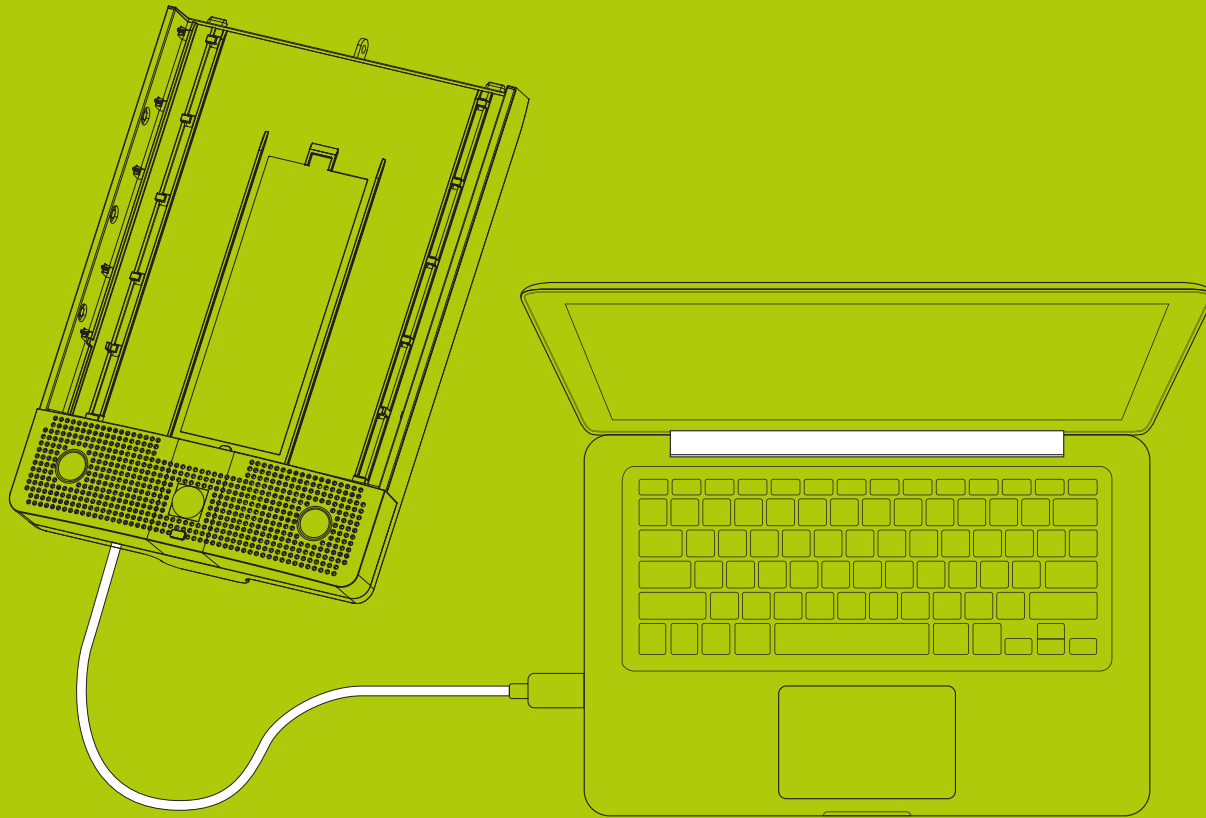

7. Go into File Explorer (or similar) and you will see the device as a USB drive. Depending upon your computer settings File Explorer may automatically open















Operational Setup

8. Open up drive to display the 4 message folders:



Plus language folders which contain the pre-saved audio messages:

- GB (UK English)
- US (US English)
- AU (Australian English)
- FR (French)
- NL (Dutch)
- FL (Flemish)
- ES (Spanish)
- IT (Italian)
- DE (German)

Name	Date modified
 IN	15/07/2020 15.31
 OUT	15/07/2020 15.31
 INOUT	15/07/2020 15.31
 TEST	15/07/2020 15.31
 GB	15/07/2020 15.31
 AU	15/07/2020 15.31
 US	15/07/2020 15.31
 ES	15/07/2020 15.31
 IT	15/07/2020 15.31
 FL	15/07/2020 15.31
 NL	15/07/2020 15.31
 DE	15/07/2020 15.31
 FR	15/07/2020 15.31

IMPORTANT

- Do not remove or add files to the TEST folder
- Do not change the names of the folder names
- If the above are carried out then the device will not function correctly

Operational Setup

9. There is a pre-saved selection of audio messages in each language folder. Play each one from your chosen 'language' folder and drag and drop the ones you want to use to the appropriate 'message' folder for your application

These are the message folder functions:



IN = for messages to be only played when walking towards the device



OUT = for messages to be only played when walking away from the device



INOUT = for messages where the device will activate regardless of direction



Where you want different messages depending upon the direction, the device will use messages from the 'IN' and 'OUT' folders. If you require this setting please ensure that there is at least 1 message in each of the 'IN' and 'OUT' folder

Please ensure that you have at least 1 message file in the folder(s) for the direction modes you intend to use

You are able to have multiple messages in each folder. Upon activation, the device will randomize the audio message played within that folder. For best results we recommend using multiple messages in the same folder so the audio messages remain impactful to the audience. There is no limit to the amount of audio messages you can save in each folder

For your convenience we have added an alert 'Beep' audio file into each Directional Folder. This 'Beep' file can be used as well as the audio messages. If the 'Beep' file is not required then you can simply delete it. Use whichever audio messages or sounds works best for your application

Setting Up Your Own Messages

10. If none of the prerecorded audio messages are appropriate for your environment, you can create your own. These can be recorded by using standard programs or apps which are on your computer (Windows or iOS), iPhone or Android phone

This device only supports **mp3, wav, wma, and acc audio files**. All other formats are not supported and will not play

On an iPhone (version iOS 13)

- (a) Use the “Voice Memos” app
- (b) Press record in the app until you have your message, play it back to check you are happy with it
- (c) Press on the 3 dots next to the recording “...”, then “share”
- (d) Select “Mail”
- (e) Email the file to yourself and then download the file to your computer
- (f) If the audio file is in m4a file format then this is not supported on this device. You will need to convert the audio file to either mp3, wav, wma or acc. For best results, we recommend either mp3 or wav. There are many free and easy to use audio file converters available online which you can use to convert your files
- (g) Once you have the files ready, drag and drop them into the correct folder as per step 9

There is no limit to the audio file length but we recommend the message is short and to the point to remain impactful

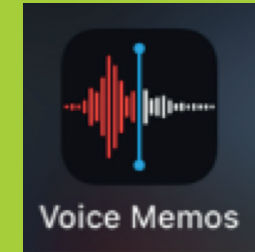

(a)



(b)

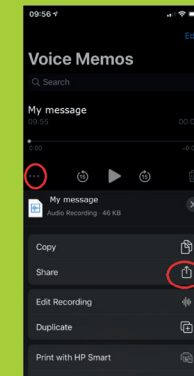

(c)

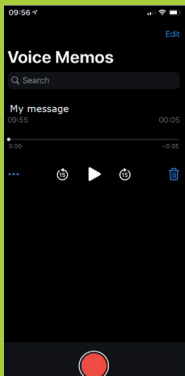

(d)

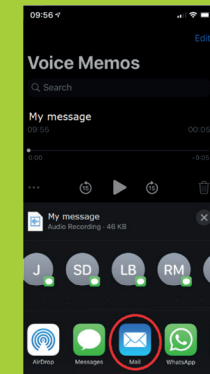

(e)

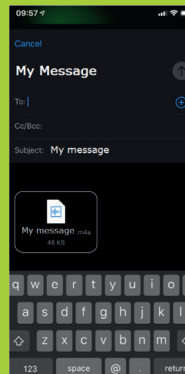

(f)

Setting Up Your Own Messages

On an Android Phone (Version Q - Android 10)

- (a) On an Android phone, each manufacturer has their own Voice Recorder app but they are similar in use. This example is using a Samsung S20. Use the “Voice Recorder” or similar app on your Android phone
- (b) Press record in the app until you have your message, play it back to check you are happy with it
- (c) Press the stop button to save the message
- (d) Once saved, hold down on the message and the share option will appear at the bottom of the screen
- (e) This will bring up a menu of sharing options. You can email the file to yourself and download the file to your computer
- (f) If the audio file is in m4a file format then this is not supported on this device. You will need to convert the audio file to either mp3, wav, wma, acc. For best results, we recommend either mp3 or wav. There are many free and easy to use audio file converters available online which you can use to convert your files
- (g) Once you have the files ready, drag and drop them into the correct folder as per step 9

There is no limit to the audio file length but we recommend the message is short and to the point to remain impactful

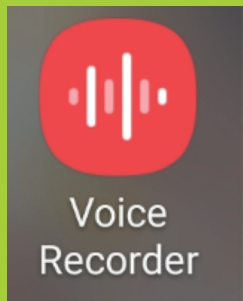

(a)

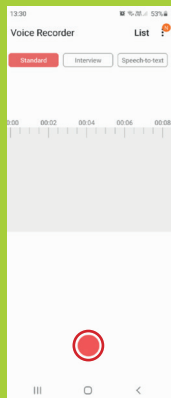

(b)



(c)

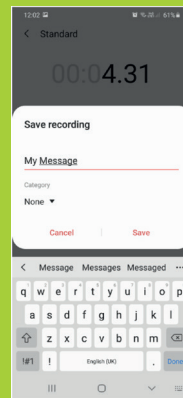

(d)

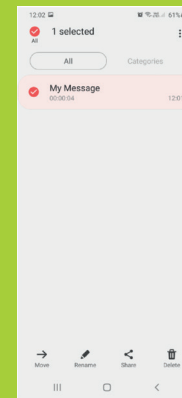

(e)

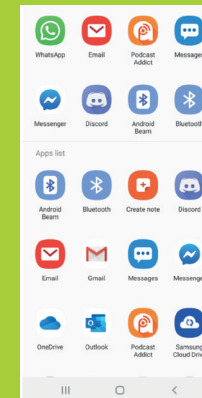

Setting Up Your Own Messages

On a Windows Computer (version 10)

- (a) Click the search box at the bottom left of your screen and search “Voice Recorder”
- (b) Launch the app and when you want to record, press on the large blue microphone button
- (c) Press stop when you have finished recording
- (d) You can now see the recorded message, play this back to check it is what you need
- (e) The file will be in C:\Users\USERNAME\Documents\Sound recordings (USERNAME = your username, C drive letter may be different on your computer)
- (f) If the audio file is in m4a file format then this is not supported on this device. You will need to convert the audio file to either mp3, wav, wma or acc. For best results, we recommend either mp3 or wav. There are many free and easy to use audio file converters available online which you can use to convert your files
- (g) Once you have the files ready, drag and drop them into the correct folder as per step 9

There is no limit to the audio file length, but we recommend the message is short and to the point to remain impactful

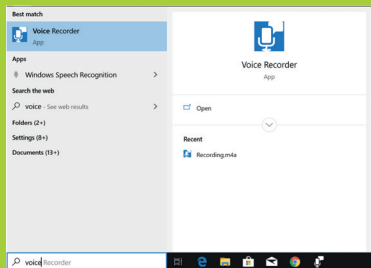

(a)

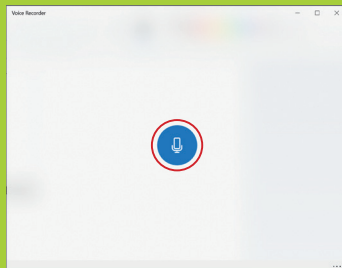

(b)

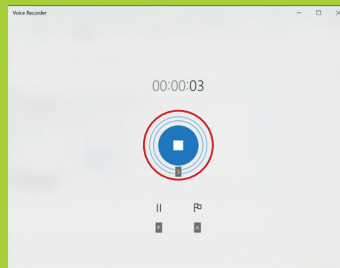

(c)

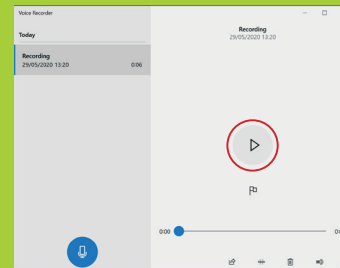

(d)

Operational Setup

11. You are able to have multiple message in each folder, the device will randomize messages within the folder on each activation
12. The device is now setup. Unplug the device from your computer
13. Check the device is working to your required settings. If not repeat steps 5-12

****You can update and change audio messages as often as you like. Updating the audio messages on a regular basis keeps the message impactful and attention grabbing****

14. Replace battery cover

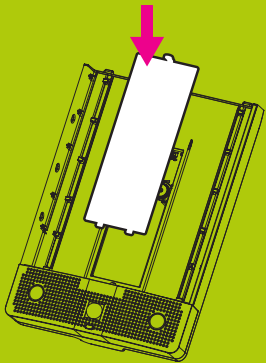

15. Slide in sign

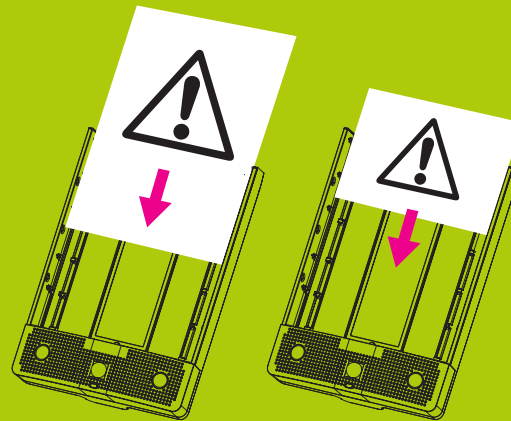

Any 7"H x 10"W landscape sign can be used.
Maximum thickness of 2mm

16. Place clear front cover back on

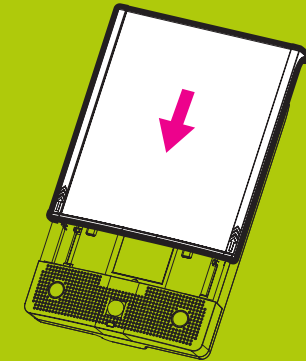

Operational Setup

17. If required use a **padlock** or a **security seal** to lockout the device

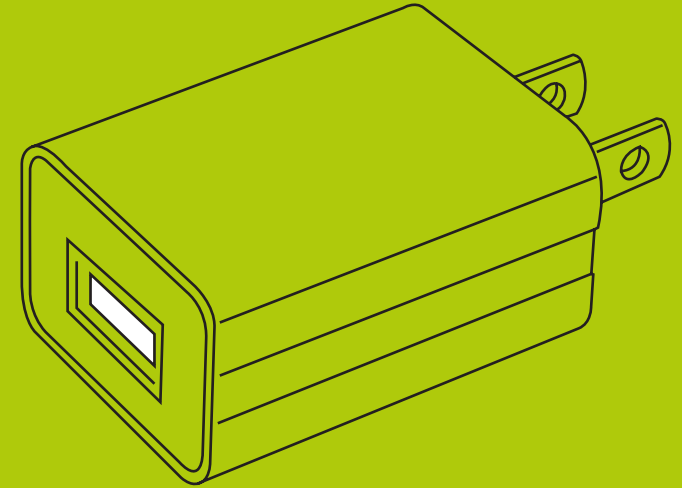

18. If you need to use AC power instead of the battery please use a **USB mains adaptor plug**

****USB AC adaptor plug not supplied****

****You can leave the batteries in if you use USB power, this will override the batteries****

Operational Setup

19. Position device into place. Multi-purpose mounting points located on the rear of the device allow for various methods of installation

(a) Attach to the wall using the wall mounting kit (screws and plugs). Please follow mounting template which is supplied with device

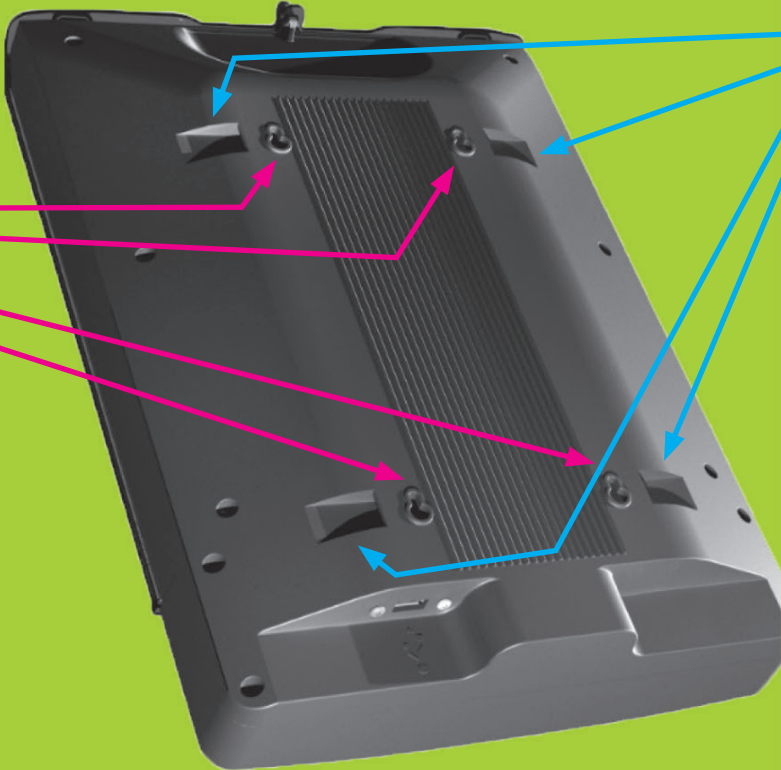

(b) Cable ties can be used for attaching to railings, fences and more

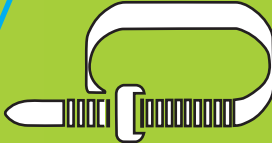

(c) Use free-standing

Positioning The Seton Safety Sign Alerter

The unit is designed to detect initial movement from up to 10' / 3m away and fully activate (based on direction) no closer than 1.6' / 0.5 m away. For best results and to maximize the full benefits of the device please follow these mounting and positional best practice notes

- (a) Use at 90 degrees to the floor or placed on a level surface
- (b) Optimal height is between 35-55 inches from the floor
- (c) Mount at 0 degrees onto the perpendicular surface to maximise the width of detection
- (d) If you cannot mount the device on a flat wall, the detection range will be impacted. We recommend you do not exceed a 20 degree angle
- (e) Make sure the device is positioned in such a way that it sees the movement toward and away, not across its detection path (unless in any direction mode)
- (f) Position away from any direct heat sources (E.g. Radiator, fan heater). Heat sources can sometimes trigger accidental activations

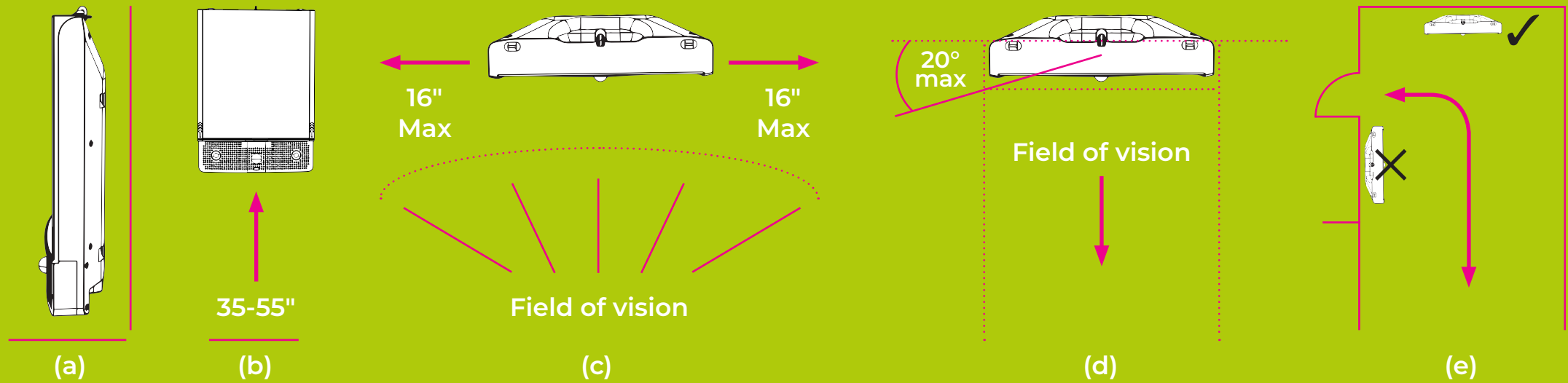

Positioning externally and in wet or dusty environments

The device has been rated to IP54 which allows for safe use internally and externally.

For best results and for longevity of performance we recommend the following when using externally and in wet or dusty environments:

- (a) Position the device in an area which is sheltered away from direct precipitation, direct continuous water flow and direct continuous dust flow
- (b) Ideally mounted on a solid surface
- (c) Avoid direct contact with jets of water

Health & Safety Information

- (a) We recommend that a risk assessment takes place before using this device
- (b) The device has a maximum volume of approx 115dB. If using the device at excessive volume, be aware of prolonged noise exposure for people nearby. The use of hearing protection may be required to prevent damage to hearing. Please refer to your local health and safety regulations
- (c) The device used LED lights. Please avoid staring directly into them
- (d) Please ensure the device is properly secured to a solid surface to prevent the device from falling which could result in personal injury
- (e) The device should not be used as the primary source of safety messaging or instructions. Before using, please consider that if the power source fails the safety message may not be conveyed to users



Maintenance

- (a) Change batteries whenever the low battery indicator flashes or every 12 months (whichever is sooner)
- (b) Regularly inspect your device for damage
- (c) Keep device clear from dust and dirt. Wipe down on a regular basis using a damp cloth
- (d) Regularly inspect the device and tighten mounts to ensure secure operation

Y4891826



IP54



Patent Pending

Made in China

Electrical Rating - 6V, 1Amp

THIS DEVICE COMPLIES WITH PART 15 OF THE FCC RULES. OPERATION IS SUBJECT TO THE FOLLOWING TWO CONDITIONS: (1) THIS DEVICE MAY NOT CAUSE HARMFUL INTERFERENCE, AND (2) THIS DEVICE MUST ACCEPT ANY INTERFERENCE RECEIVED, INCLUDING INTERFERENCE THAT MAY CAUSE UNDESIRE OPERATION.

CAN ICES-3(A) / NMB-3(A)

If you have any problems or require further information:

seton.ca/alerter

800-263-1623

ServiceCanada@seton.com